



"Look for the blue label!"

The G2 Industrial Brass Meter allows another choice for fluid compatibility. The FLOMEC® Brass Meter works well with most water applications. Use with glucose, lacquer thinners and vegetable juices for example.

\* ISO 7 designation is RC

For complete part number, see "Meter Number Reference" for this section.

### Select Your Meter Size:

1/2 inch 3/4 inch 1 inch 1-1/2 inch 2 inch



### Features and Benefits:

- ✓ Meter is designed for thin fluids < 100 cp.
- ✓ Modular design allows for use with Output Modules, Sensors and Remote Transmitters.
- ✓ 2 Totals (Batch = Resettable, Cumulative = Non-Resettable); Rate of Flow. Factory calibrated in gallons and litres. Field calibratable. Allows user calibration. Includes non-volatile totals.
- ✓ Internal parts are simple to replace for easy maintenance.
- ✓ Lithium battery life: 5 years.

### BRASS – SPECIFICATIONS

<b>Fitting Type:</b>	NPT or ISO (Female) BSPT*				
<b>Housing Material:</b>	Brass				
<b>Meter Sizes Available:</b>	1/2"	3/4"	1"	1-1/2"	2"
<b>Flow Range:</b>	1/2" (B05)	1 - 10 GPM	(3.8 - 37.9 LPM)		
	3/4" (B07)	2 - 20 GPM	(7.6 - 75.7 LPM)		
	1" (B10)	5 - 50 GPM	(18.9 - 190 LPM)		
	1-1/2" (B15)	10 - 100 GPM	(38.0 - 380 LPM)		
	2" (B20)	20 - 200 GPM	(76 - 760 LPM)		
<b>Accuracy (% of Reading):</b>		<b>Turbine Only</b>	<b>Turbine w/Display</b>		
	1/2" (B05)	± 2.0%	± 1.5%		
	3/4" (B07)	± 1.5%	± 1.0%		
	1" (B10)	± 1.5%	± 1.0%		
	1-1/2" (B15)	± 1.0%	± 0.75%		
	2" (B20)	± 1.0%	± 0.75%		
<b>Repeatability:</b>	± 0.1%				
<b>Pressure Rating:</b>	300 PSI / 21 BAR				
<b>Operating Temperature Range:</b>	-40° F to +250° F (-40° C to +121° C)				
<b>with Display:</b>	0° F to +140° F (-18° C to +60° C)				
<b>Typical K-Factor:</b>	1/2" (B05)	2,500 PPG / 660 PPL			
	3/4" (B07)	1,100 PPG / 291 PPL			
	1" (B10)	565 PPG / 149 PPL			
	1-1/2" (B15)	215 PPG / 57 PPL			
	2" (B20)	100 PPG / 26 PPL			
<b>Wetted Materials:</b>	<b>Housing:</b>	Brass			
	<b>Bearings:</b>	96% Alumina Ceramic			
	<b>Shaft:</b>	Tungsten Carbide			
	<b>Rotor:</b>	PVDF			
	<b>Rings:</b>	316 Stainless Steel			
<b>Frequency Range:</b>	1/2" (B05)	42 - 420 Hz @ 1 - 10 GPM			
	3/4" (B07)	37 - 370 Hz @ 2 - 20 GPM			
	1" (B10)	47 - 470 Hz @ 5 - 50 GPM			
	1-1/2" (B15)	36 - 360 Hz @ 10 - 100 GPM			
	2" (B20)	33 - 330 Hz @ 20 - 200 GPM			
<b>Recommended Strainer Size:</b>	1/2" (B05)	60 mesh (250 micron)			
	3/4" (B07)	60 mesh (250 micron)			
	1" (B10)	60 mesh (250 micron)			
	1-1/2" (B15)	30 mesh (595 micron)			
	2" (B20)	30 mesh (595 micron)			
<b>Maximum Flow:</b>	1/2" (B05)	15 GPM (56.8 LPM)			
	3/4" (B07)	30 GPM (113.6 LPM)			
	1" (B10)	75 GPM (284 LPM)			
	1-1/2" (B15)	150 GPM (568 LPM)			
	2" (B20)	300 GPM (1,136 LPM)			
<b>Wrench Flat Size:</b>	1/2" (B05)	1-1/16 inch (27 mm)			
	3/4" (B07)	1-5/16 inch (33 mm)			
	1" (B10)	1-5/8 inch (41 mm)			
	1-1/2" (B15)	2-3/8 inch (60 mm)			
	2" (B20)	3 inch (75 mm)			
<b>Shipping Weight:</b>	1/2" (B05)	2.4 lbs./1.0 kg - Turbine Only; 2.2 lbs./1.0 kg			
	3/4" (B07)	2.6 lbs./1.1 kg - Turbine Only; 2.4 lbs./1.0 kg			
	1" (B10)	3.1 lbs./1.4 kg - Turbine Only; 2.9 lbs./1.3 kg			
	1-1/2" (B15)	3.1 lbs./1.4 kg - Turbine Only; 2.9 lbs./1.3 kg			
	2" (B20)	10.0 lbs./4.5 kg - Turbine Only; 9.8 lbs./4.4 kg			
<b>Calibration Report</b>	Comes standard with G2 Series meters. N.I.S.T. – Certification available.				

### ELECTRONIC CHOICES

**Local Display, Remote Display & Remote Transmitter Options:** See Electronics Section.

### APPROVALS



## G2 Series Industrial Grade Meters

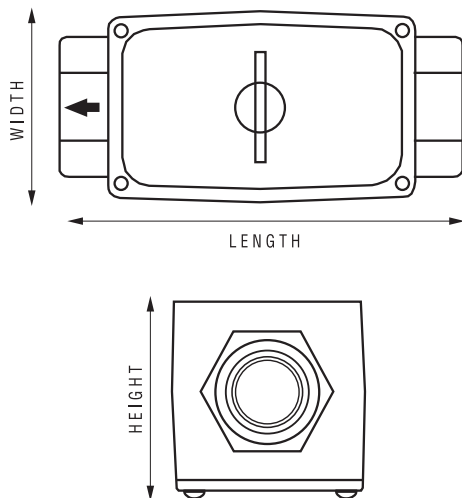

Model	Length inches (mm)	Height inches (mm)	Width inches (mm)	Model	Length inches (mm)	Height inches (mm)	Width inches (mm)
A05	4.2 (107)	1.8 (46)	2.0 (51)	H20	6.3 (160)	3.2 (81)	3.3 (84)
A07	4.3 (109)	2.0 (51)	2.0 (51)	P05	7.3 (185)	3.2 (81)	2.1 (53)
A10	4.5 (114)	2.2 (56)	2.0 (51)	P10	8.1 (206)	3.3 (84)	2.8 (71)
A15	5.3 (135)	2.8 (71)	2.7 (68)	S05	4.2 (107)	1.8 (46)	2.0 (51)
A20	6.3 (160)	3.2 (81)	3.3 (84)	S07	4.3 (109)	2.0 (51)	2.0 (51)
<b>B05</b>	<b>4.2 (107)</b>	<b>1.8 (46)</b>	<b>2.0 (51)</b>	S10	4.5 (114)	2.2 (56)	2.0 (51)
<b>B07</b>	<b>4.3 (109)</b>	<b>2.0 (51)</b>	<b>2.0 (51)</b>	S15	5.3 (135)	2.8 (71)	2.7 (68)
<b>B10</b>	<b>4.5 (114)</b>	<b>2.2 (56)</b>	<b>2.0 (51)</b>	S20	6.3 (160)	3.2 (81)	3.3 (84)
<b>B15</b>	<b>5.3 (135)</b>	<b>2.8 (71)</b>	<b>2.7 (68)</b>	S10F	6.75 (171)	4.25 (108)	4.25 (108)
<b>B20</b>	<b>6.3 (160)</b>	<b>3.2 (81)</b>	<b>3.3 (84)</b>	S15F	8.0 (203)	5.0 (127)	5.0 (127)
C05	7.3 (185)	3.2 (81)	2.1 (53)	S20F	9.50 (241)	6.0 (152)	6.0 (152)
C10	8.1 (206)	3.3 (84)	2.8 (71)	S05T	5.0 (127)	2.0 (51)	1.8 (46)
H05	4.2 (107)	1.8 (46)	2.0 (51)	S07T	5.0 (127)	2.0 (51)	2.0 (51)
H07	4.3 (109)	2.0 (51)	2.0 (51)	S10T	5.5 (140)	2.0 (51)	2.2 (56)
H10	4.5 (114)	2.2 (56)	2.0 (51)	S15T	6.5 (165)	2.7 (68)	2.8 (71)
H15	5.3 (135)	2.8 (71)	2.7 (68)	S20T	7.0 (178)	3.3 (84)	3.2 (81)

NOTE: 09 Display adds 0.68 in. (17.3 mm) to height.

NOTE: Dimensions are for reference only and may vary by model.

## Product Identifier

**G2** = Industrial Grade Meter

## Turbine Material & Size

### Metal Meters:

- S05** = Stainless Steel – 1/2 in.
- S07** = Stainless Steel – 3/4 in.
- S10** = Stainless Steel – 1 in.
- S15** = Stainless Steel – 1-1/2 in.
- S20** = Stainless Steel – 2 in.
- H05** = Stainless Steel High Pressure – 1/2 in.
- H07** = Stainless Steel High Pressure – 3/4 in.
- H10** = Stainless Steel High Pressure – 1 in.

- H15** = Stainless Steel High Pressure – 1-1/2 in.
- H20** = Stainless Steel High Pressure – 2 in.
- A05** = Aluminum – 1/2 in.
- A07** = Aluminum – 3/4 in.
- A10** = Aluminum – 1 in.
- A15** = Aluminum – 1-1/2 in.
- A20** = Aluminum – 2 in.
- B05** = Brass – 1/2 in.
- B07** = Brass – 3/4 in.

- B10** = Brass – 1 in.
- B15** = Brass – 1-1/2 in.
- B20** = Brass – 2 in.

### Plastic Meters:

- P05** = PVDF – 1/2 in.
- P10** = PVDF – 1 in.

## Fitting Type

- F** = 150# ANSI Flange - available on S10, S15 and S20 only
- I** = ISO (Female) BSPT\*
- N** = NPT (Female)
- T** = Tri-Clover® Fitting - available on S05 - S20 only
- X** = Electronics Only - for metal meters
- Z** = Electronics Only - for plastic meters

See Reference section for meter dimensions.

## Electronic Choice

### Turbine with Local Display

- 09** = 2 Button Computer, Field Configurable (2 Totals and Rate of Flow)
- 19** = Vertical Mount 2-Button Computer, Field Configurable (2 Totals and Rate of Flow)

### Pulse Output (Remote)

- 41** = Remote Pulse Out Transmitter & Sine Wave Pickup (Standard Remote Sensor Option)
- 43** = Remote Pulse Out Transmitter & Turbine Mounted Computer (Pulse Out Sensor Option)

### GG500 – Display with Pulse Output (Remote)

- 51** = Sine Wave Pickup (Standard Remote Sensor Option)
- 52** = Open Collector Pickup (Conditioned Signal Sensor Option)
- 53** = Turbine Mounted Computer (Pulse Access Sensor Option)

### GX500 – Display with 4-20 mA Output (Remote)

- 61** = Sine Wave Pickup (Standard Remote Sensor Option)
- 62** = Open Collector Pickup (Conditioned Signal Sensor Option)
- 63** = Turbine Mounted Computer (Pulse Access Sensor Option)

### GA500 – 4-20 mA Output (Remote)

- 71** = Sine Wave Pickup (Standard Remote Sensor Option)
- 72** = Open Collector Pickup (Conditioned Signal Sensor Option)
- 73** = Turbine Mounted Computer (Pulse Access Sensor Option)

### No Electronics – Turbine Only

- XX** = No Electronics – Turbine Only

## Calibration

- GM** = Gallons / Minute
- LM** = Litres / Minute
- XX** = No Computer

## Packaging

- A** = Use for Turbine Only or Turbine w/Display (Sizes 05-10)
- B** = Use for Turbine Only or Turbine w/Display (Sizes 15-20)
- C** = Use for Turbine with Remote Transmitter With or Without Turbine Mounted Display (Sizes 05-20)
- D** = Use for 150# ANSI Flange Turbine Only (Size 10)
- E** = Use for 150# ANSI Flange Turbine Only (Sizes 15-20) Use for 150# ANSI Flange Turbine with Remote Transmitter (Sizes 10, 15 or 20)









**G2** + **S07** + **N** + **09** + **GM** + **A** ← (Sample Model Number)

\* ISO 7 designation is RC

At Great Plains Industries, we've been building rugged, reliable, liquid flowmeters for over 35 years. The GPI Industrial Meter family includes a full line of Precision and Industrial Turbine meters plus Oval Gear meters in various materials, sizes and fitting options.

We design products to meet the needs of our customers. This includes maintaining appropriate, industry standard approvals. Approvals vary by product line and may be dependent on meter application.

The Approval symbol is listed under product specifications on individual product pages. If no approval mark is found, check the chart to the right. For details about specific "Approvals" refer to the chart.

<p><b>3-A</b></p>	<p><b>3-A Sanitary Standards, Inc.</b> "Flowmeters for Milk and Milk Products, Number 28-03" for GSCPS Models and L Option Meters.</p>
<p><b>ATEX</b> </p>	<p><b>Ex II 1 G</b> Per 94/9/EC.</p>
<p></p>	<p>Product reviewed for EMC Directive 2004/108/EC. Includes: Euro Norms 61000-6-2 (2005) and 61000-6-3 (2007) on A1 and G2 Series Meters. Note: For <b>Oval Gear Meters</b>, the CE Approval is applied when meter is part of a system.</p>
<p></p>	<p><b>Factory Mutual Approved</b> Intrinsically Safe for Class I, II, III, Division 1, All Groups. Nonincendive for Class I, II, III, Division 2 Groups A, B, C, D, F, G.</p>
<p></p>	<p><b>Factory Mutual Approved</b> Class 1, Div. 1, Group D (01A31GM Only)</p>
<p></p>	<p><b>Factory Mutual Approved</b> Intrinsically safe for Class I &amp; II, Div. 1, Groups A, B, C, D, E, F &amp; G, T6 Ta=-40° C to 60° C hazardous locations, and for use in Class I, Zone 0 as Ex is IIC T6 Ta=-40° C to 60° C.</p>
<p></p>	<p><b>Federal Communication Commission</b> Industry Canada Approval Class B; digital service, part 15 of FCC Rules.</p>
<p></p>	<p><b>Ex ia IIC T6 Ta=60° C</b></p>
<p><b>IP44/IP54/IP66</b></p>	<p><b>Ingress Protection Code</b> IP44 (Greater than 1 mm and splashed water); IP54 (Dust protected and splashed water); IP66 (Dust-tight and heavy seas).</p>
<p><b>IP/NEMA</b></p>	<p>Pulse versions of <b>Oval Gear Meters</b> have enclosure ratings that vary from IP54 / NEMA 13 to IP66 / NEMA 16 depending on the application.</p>
<p><b>NEMA</b> <b>4</b></p>	<p>NEMA Requirements: Enclosure constructed for indoor or outdoor use to provide a degree of protection to personnel against incidental contact with the enclosed equipment. Protection against falling dirt, rain, sleet, snow, windblown dust, splashing or hose directed water that will be undamaged by the external formation of ice on the enclosure. <i>GPI products are tested to NEMA requirements.</i></p>
<p></p>	<p>Restriction of Hazardous Substances Directive 2002/95/EC and 2011/65/EU</p>
<p></p>	<p>Indicates that the product was tested and has met the certification requirements for electrical, plumbing and/or mechanical products.</p>